

CAD files / 3D models for printing

Nucular controller P24F

[Download STEP](#)



P24F to surface mount

[Adapter simple STEP+STL](#)

[Adapter with fan STEP+STL](#)



Display v11

nucular_display_simple.zip

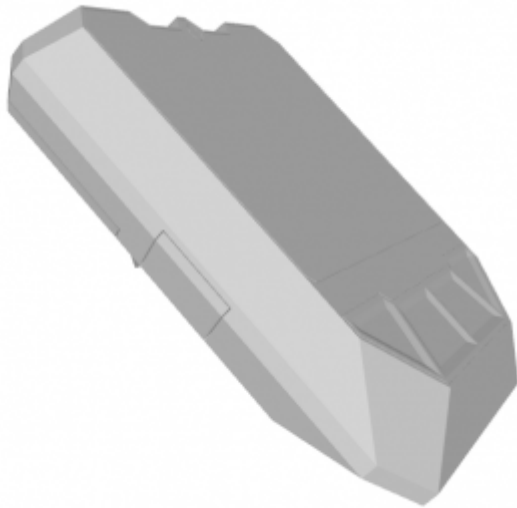

Display v10 button pusher

[External Link](#)

button_pusher10.2.step.zip

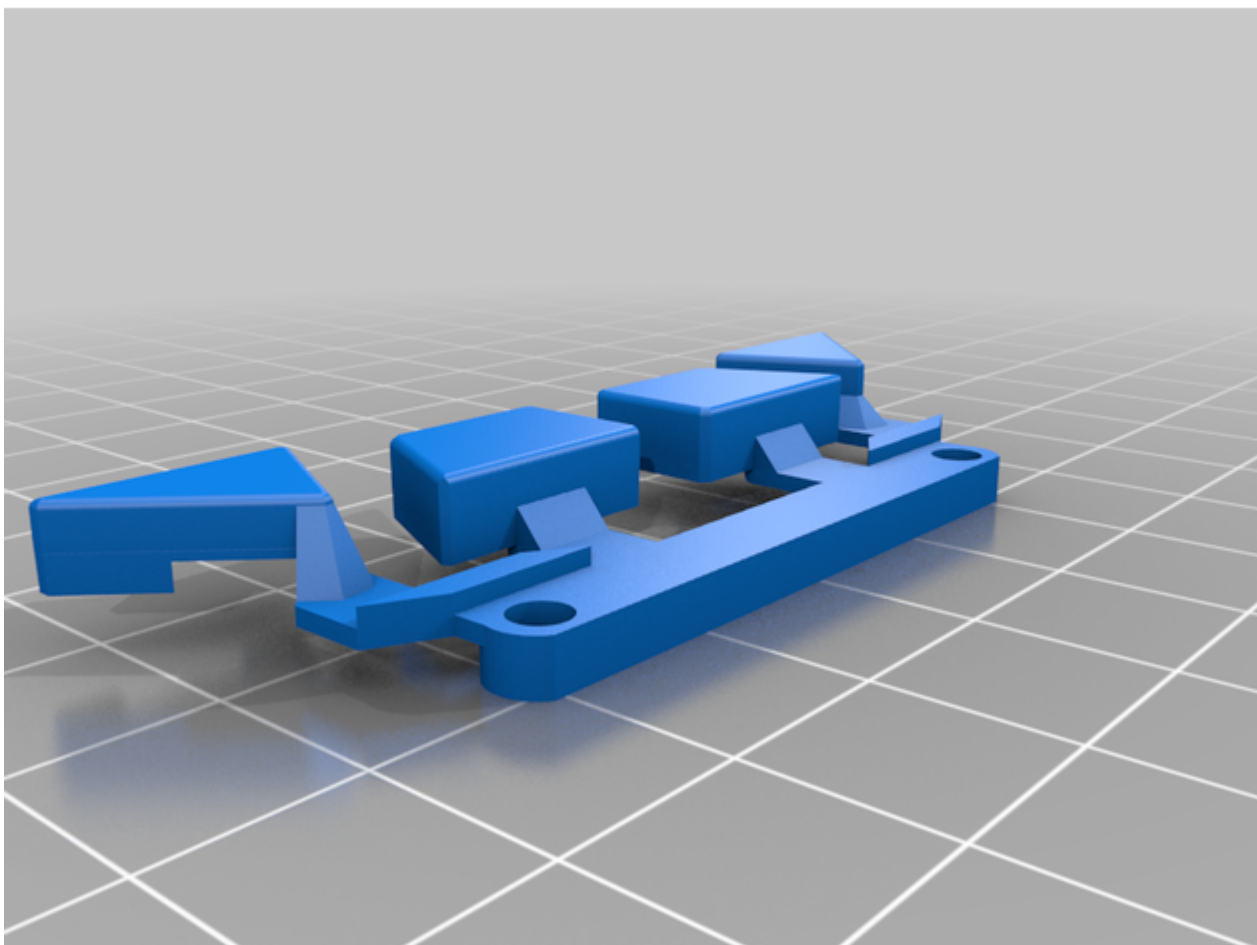

User-made models

uLight box for Sur-Ron

[External Link](#)



Nucular controller 24F mount Sur-Ron

[External Link](#)



Thermo Nucular 24F Controller Simple drawing

[External Link](#)

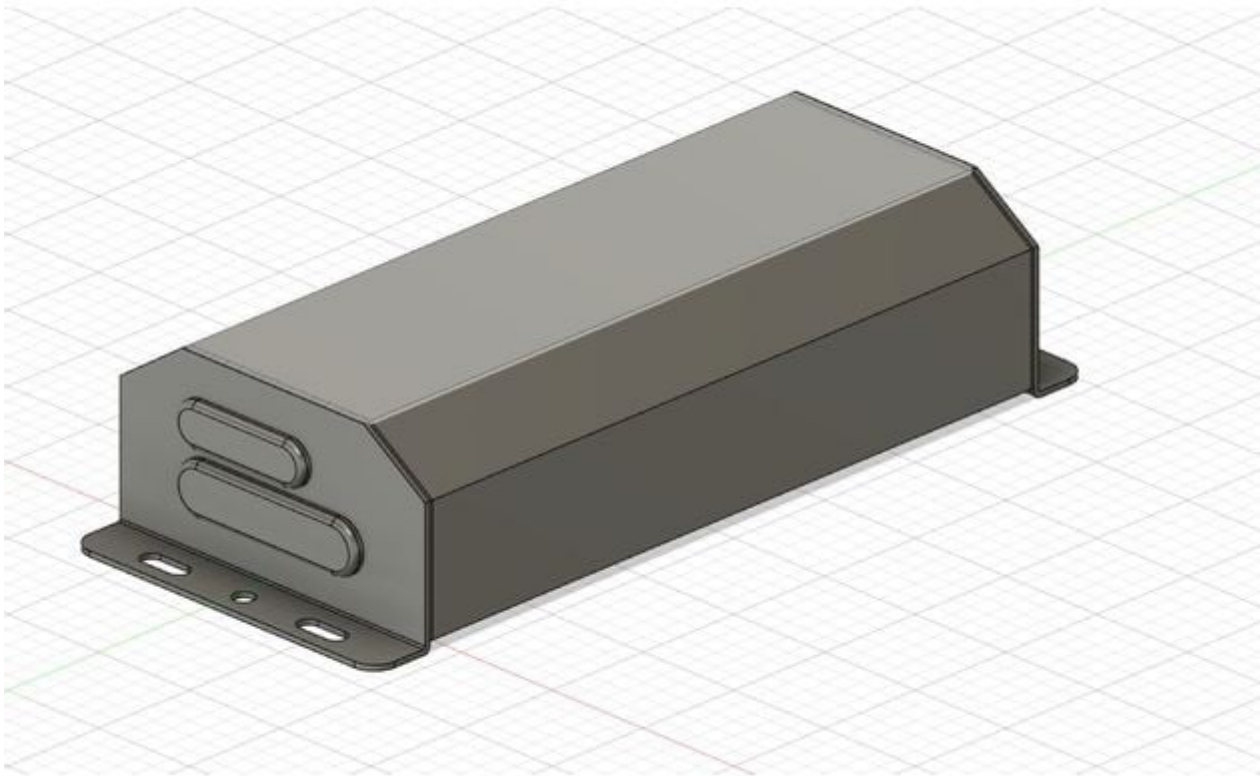

Sur-ron Nucular controller (NUC 24f) mount V2

[External Link](#)



Encoder adapter to SurRon LB

[External Link](#)



Nucular P24F Surface Mount for Vortex frame

[External Link](#)

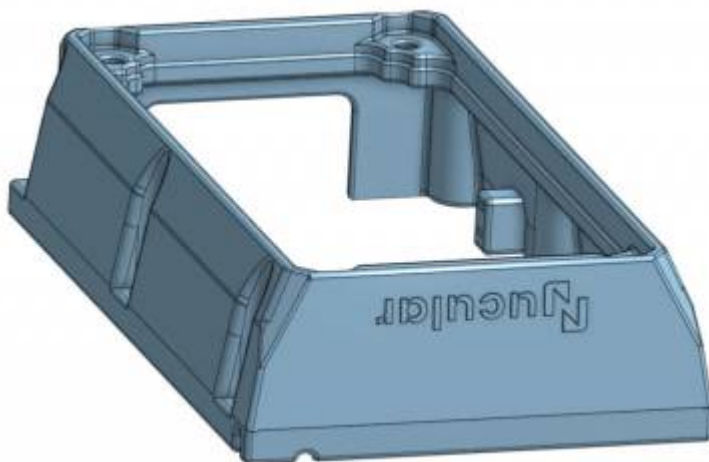

From:

<https://docs.nucular.tech/> - **Nucular Electronics**

Permanent link:

<https://docs.nucular.tech/doku.php?id=en:cadmodels&rev=1693912154>

Last update: **2023/09/05 13:09**